

ENTERPRISE

Jewellery Machinerics Equipments & Plants

 **75676 58468**  **75675 73875**

 Parmeshwar Society Main Road, Nr. Atika Fatak,
ATIKA, Rajkot-360 002. (Guj.- INDIA)

Laser Soldering Gun. (LPG)



Laser Soldering Gun 2kg.

Laser Soldering Gun 5kg.

Laser Soldering Gun 14kg.

Code	Model type	Price
1	2 KG CYLINDER FITTING	

Code	Model type	Price
2	5 KG CYLINDER FITTING	

Code	Model type	Price
3	14 KG CYLINDER FITTING	

Laser Soldering Gun. (LPG)



Laser Soldering Gun Nut.

Code	Model type	Price
4	3/8 Nut CYLINDER FITTING	



Laser Soldering Gun Combo.

Code	Combo	Price
5	14kg./ 2kg./ 5 kg. CYLINDER FITTING	



PU Pipe 100m for Laser

Code	Model type	Price
6	PU Pipe 4x2.5mm.	

Spare Parts Laser Soldering Gun. (LPG)



14Kg Nipple

5Kg jointer Nipple

14Kg Nipple

3/8 NUT

2Kg Valve Nipple

5Kg Valve Nipple

Code Price

7

Code Price

8

Code Price

9

Code Price

10

Code Price

11

Code Price

12



Laving 00

Laving 0

Laving 1

Laving 2

Laving 3

Code Price

13

Code Price

14

Code Price

15

Code Price

16

Code Price

17

Spare Parts Laser Soldering Gun. (LPG)



Big Burner

<i>Code</i>	<i>Model type</i>	<i>Price</i>
-------------	-------------------	--------------

18	3/8	
----	-----	--



Small Burner

<i>Code</i>	<i>Model type</i>	<i>Price</i>
-------------	-------------------	--------------

19	3	
----	---	--



LPG. Filter

<i>Code</i>	<i>Model type</i>	<i>Price</i>
-------------	-------------------	--------------

20	LPG	
----	-----	--

Soldering Gas Gun Box. (LPG)



Soldering Gas Gun Big Box

Code	Model type	Price
21	1 Line Big	
22	2 Line Big	

Soldering Gas Gun CD Box

Code	Model type	Price
23	1 Line	
24	2 Line	

New Double Presser Soldering Gas Gun

Code	Model type	Price
25	1 Line New	
26	2 Line New	

Soldering Gas Gun. (LPG)



1 Line Open Soldering Gas Gun

Code

Model type

Price

27

Open



Petrol Pipe 1/4

Code

Model type

Price

28

Regular



Double Compressor Soldering Gas Gun

Code

Model type

Price

29

2 Line

Spare Parts Soldering Gas Gun. (LPG)



Steel Soldering Gun

Code

Price

30



Brass Soldering Gun

Code

Price

31



Fully Brass Soldering Gun

Code

Price

32



Big Valve

Code

Price

33



Compressor

Code

Price

34

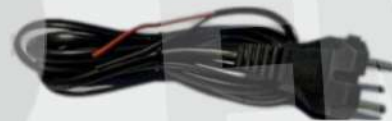

Electric Wire

Code

Price

35



Regulator

Code

Price

36



Small setting Valve

Code

Price

37

Casting Ingot Mould.



4&2 Line Ingot Mould

Code	Model type	Price	Code	Model type	Price
44	4"		48	12"	
45	6"		49	14"	
46	8"		50	16"	
47	10"		51	18"	

5 Line Square Ingot Mould

Code	Model type	Price
52	6"	
53	8"	
54	10"	
55	12"	
56	14"	

Spare Parts Soldering Gas Gun. (LPG)



Plastic Dabbi

Code

Price

38



Head Rubber Set

Code

Price

39



Magnet Patti

Code

Price

40



Plastic T Nipple

Code

Price

41



Hammer No. 1 With Handle

Code

Model type

Price

42

Hammer No 1



Hammer No0. With Handle

Code

Model type

Price

43

Hammer No 0.

Casting Ingot Mould.



1 Line Ingot Mould

<i>Code</i>	<i>Model type</i>	<i>Price</i>
-------------	-------------------	--------------

<i>57</i>	<i>15mmx2"x14"L</i>	
-----------	---------------------	--



1 Line Ingot Mould

<i>Code</i>	<i>Model type</i>	<i>Price</i>
-------------	-------------------	--------------

<i>58</i>	<i>15mmx1.5"x14"L</i>	
-----------	-----------------------	--



1 Line Ingot Mould

<i>Code</i>	<i>Model type</i>	<i>Price</i>
-------------	-------------------	--------------

<i>59</i>	<i>15mmx1.25"x14"L</i>	
-----------	------------------------	--

<i>A59</i>	<i>15mmx1"x14"L</i>	
------------	---------------------	--

Casting Ingot Mould.



1 Line Ingot Mould

Code	Model type	Price
60	16mmx16mmx18''L	
A60	12.5mmX12.5mmX18''L	

1 Line Ingot Mould

Code	Model type	Price
61	8mmx8mmx12''L	
62	10mmx10mmx12''	
63	12mmx12mmx12''	
64	12mmx16mmx12''	
65	12mmx18mmx12''L	

1 Line Ingot Mould

Code	Model type	Price
66	0.5''x0.5''x15''	
67	0.5''x0.75''x15''	

Casting Ingot Mould.



2 & 1 Line Ingot Mould

Biscuit Mould 6 In 1

Code

Model type

Price

Code

Model type

Price

68

6"

69

25gm To 500gm

Casting Ingot Mould.

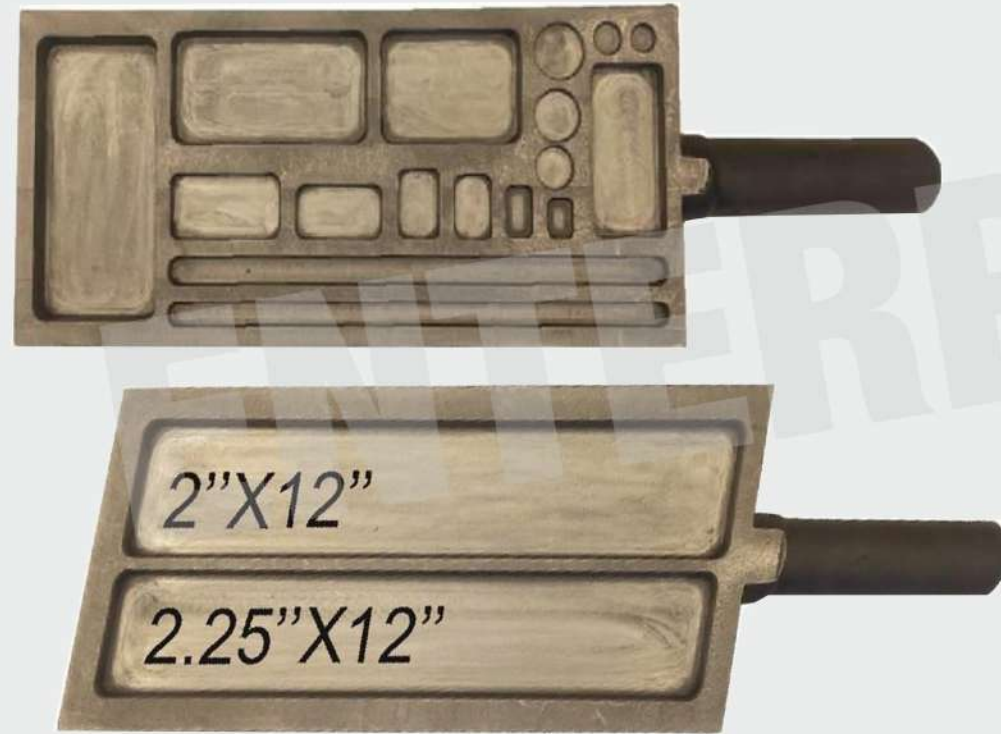

All In 1 Double Side

Code

Model type

Price

71

0.05Gm To 1 KG & Sheet

Silver & Gold Casting Ingot Mould.



5Kg Silver & 10kg. Gold Capacity

<i>Code</i>	<i>Model Type</i>	<i>Price kg</i>
72	41x103x153mm	



3Kg Silver & 6kg. Gold Capacity

<i>Code</i>	<i>Model Type</i>	<i>Price kg</i>
73	39x78x128mm	



2Kg Silver & 4kg. Gold Capacity

<i>Code</i>	<i>Model Type</i>	<i>Price kg</i>
74	38x50x108mm	



1Kg Silver & 2kg. Gold Capacity

<i>Code</i>	<i>Modal Type</i>	<i>Price kg</i>
75	15x65x136mm	



0.500gm Silver & 1kg. Gold Capacity

<i>Code</i>	<i>Modal Type</i>	<i>Price kg</i>
76	11.5x52x110mm	

Casting Ingot Mould.



300gm Silver & 500gm. Gold Capacity

Code	Model Type	Price kg
77	10.5x50x75mm	



200gm Silver & 400gm. Gold Capacity

Code	Model Type	Price kg
78	9.5x40x75mm	



100gm Silver & 200gm. Gold Capacity

Code	Model Type	Price kg
79	11.5x52x110mm	



50gm Silver & 100gm. Gold Capacity

Code	Model Type	Price kg
80	6x25x45mm	



25gm Silver & 50gm. Gold Capacity

Code	Model Type	Price kg
81	6x20x30mm	



Biscuit Mould 3in1

Code	Model Type	Price kg
82	25gm,50gm&100gm	

Casting Ingot Mould.



Semi Finish 1 Line Ingot Mould

Code	Model type	Price kg
83	15mmX2''X14''L.	



Semi Finish 1 Line Ingot Mould Half Round Way

Code	Model type	Price kg
86	16mmX16mmX18''L	
A86	12.5mmX12.5mmX18''L	

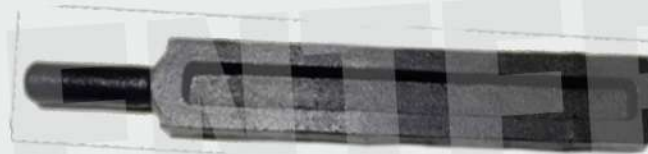

Semi Finish 1 Line Ingot Mould

Code	Model type	Price kg
84	15mmX1.5''X14''L.	



Semi Finish 1 Line Ingot Mould

Code	Model type	Price kg
87	12mmx12mmx15''	



Semi Finish 1 Line Ingot Mould

Code	Model type	Price kg
85	15mmX1''X14''L.	



Semi Finish 4&1 Line Ingot Mould

Code	Model type	Price kg
88	B	

Casting Ingot Mould.



Semi Finish 4&2 Line Ingot Mould

Code	Model type	Price Kg	Code	Model type	Price Kg
89	4"		92	10"	
90	6"		93	12"	
91	8"		94	14"	
			95	16"	
			96	18"	

Semi Finish 5&3 Line Ingot Mould

Code	Model type	Price Kg
97	Half Round Way F	



Semi Finish 5&3 Line ingot Mould

Code	Model type	Price kg
98	Half Round Way D	

Casting Ingot Mould.



Semi Finish Biscuit Ingot Mould.

<i>Code</i>	<i>Model type</i>	<i>Product Weight</i>	<i>Price</i>	<i>Code</i>	<i>Model type</i>	<i>Product Weight</i>	<i>Price kg</i>
<i>103</i>	<i>20Kg Silver 65x120x250</i>	<i>9.830</i>		<i>108</i>	<i>4Kg Silver Capacity 42x65x125</i>	<i>3.060</i>	
<i>104</i>	<i>15Kg Silver 65x100x230</i>	<i>7.350</i>		<i>109</i>	<i>3Kg Silver Capacity 40x60x142</i>	<i>2.440</i>	
<i>105</i>	<i>9to10Kg Silver 52x75x150</i>	<i>5.115</i>		<i>110</i>	<i>2Kg Silver Capacity 38x50x113</i>	<i>1.930</i>	
<i>106</i>	<i>7to8Kg Silver 52x75x150</i>	<i>4.470</i>		<i>111</i>	<i>1Kg Silver Capacity 32x40x90</i>	<i>1.255</i>	
<i>107</i>	<i>5to6Kg Silver 52x75x150</i>	<i>3.535</i>		<i>112</i>	<i>500Gm Silver Capacity 25x30x65</i>	<i>0.670</i>	

Casting Ingot Mould.



Semi Finish 2&1 Line ingot Mould

Code	Model type	Price kg
99	6"	



Semi Finish Ingot Mould Half Round Way

Code	Model type	Price kg
100	32mm x 32mm x 16"	
101	32mm x 32mm x 18"	
102	32mm x 32mm x 20"	

Casting Ingot Mould.

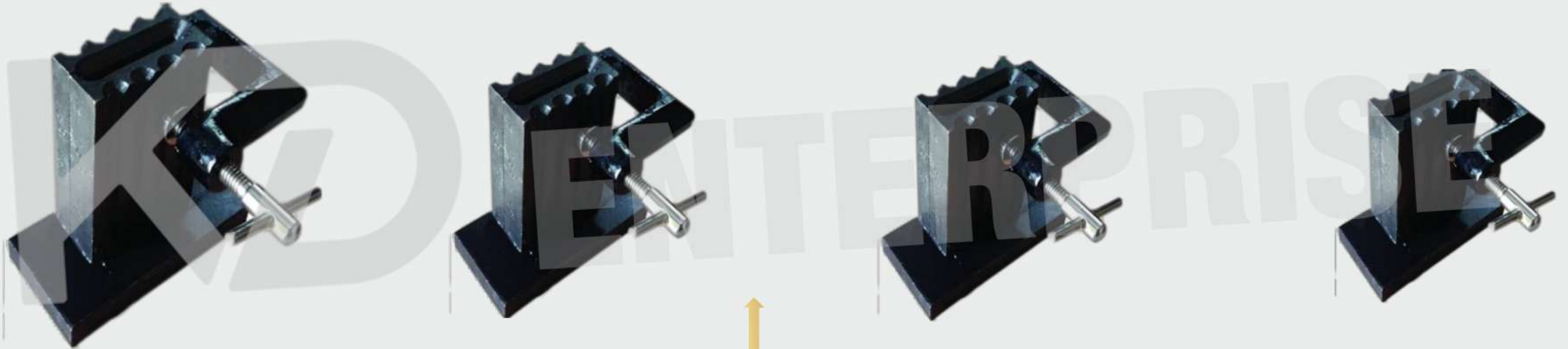

Stand Raja

<i>Code</i>	<i>Model type</i>	<i>Price</i>	<i>Code</i>	<i>Model type</i>	<i>Price</i>
113	1 Number		118	6 Number	
114	2 Number		119	7 Number	
115	3 Number		120	8 Number	
116	4 Number		121	9 Number	
117	5 Number		122	10 Number	



Ring Expanding Machine

Ring Expanding Banding M/c.

Ring Expanding M/c. Italy

Code	Model type	Price	Code	Model type	Price	Code	Model type	Price
123	1 to 36 stick Marking		129	1 to 36 Bending		135	1 to 36 Italy	
124	1 to 36 (6 Spain)		130	1 to 36 (6 Spain)		136	1 to 36 (6 Spain)	
125	1 to 15 Stick Marking		131	1 to 15 Bending		137	1 to 15 Italy	
126	1 to 15 (6 Spain)		132	1 to 15 (6 Spain)		138	1 to 15 (6 Spain)	
127	1 to 16 Stick Marking		133	1 to 16 Bending		139	1 to 16 . Italy	
128	1 to 16 (6 Spain)		134	1 to 16 (6 Spain)		140	1 to 16 (6 Spain)	

Goldsmith tools & Machinery



Ring Expanding M/c. Step Stick

<i>Code</i>	<i>Model type</i>	<i>Price</i>
141	1 to 10 Step Stick	



Ring Expanding M/c. Double Stick

<i>Code</i>	<i>Model type</i>	<i>Price</i>
142	Double Stick 1 to 36	



Ring Expanding M/c. Mini

<i>Code</i>	<i>Model type</i>	<i>Price</i>
143	Mini 1 to 36	
144	Mini 1 to 15	

Goldsmith tools & Machinery)



Brass Nipple

Code	Model type	Price
145	3 Way	



Brass Nipple

Code	Model type	Price
146	4 Way	



Concave Doming Plates

Code	Model type	Price
147	4"	
A147	5"	
B147	6"	

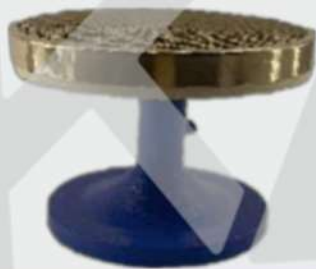

Soldering Revolving Stand

Code	Model type	Price
148	Regular	



Soldering Hand Stand

Code	Model type	Price
149	Regular	



Asbestos Sheet

Code	Model type	Price
150	As Your Req.	

Soldering Tools



LPG Burner Gun

<i>code</i>	<i>Model Type</i>	<i>Price</i>
159	2"	
160	4"	
161	6"	
162	8"	
163	10"	



LPG Burner

<i>Code</i>	<i>Model type</i>	<i>Price</i>
164	0	
165	1	
166	2	
167	2.5	
168	3	
169	4	



High Pressure Regulator

<i>Code</i>	<i>Model type</i>	<i>Price</i>
170	Nipple	
171	3/8. Thread Type	

Soldering Tools & Chemical



P.V.C. Bowl

Code	Model type	Price
151	4"	
152	5"	
153	6"	

Soldering Water

Code	Model type	Price
154	100ML	
155	200ML	
156	400ML	
157	1Ltr	

Soldering Borex Bar

Code	Model type	Price
158	600gm.	

Soldering Tools

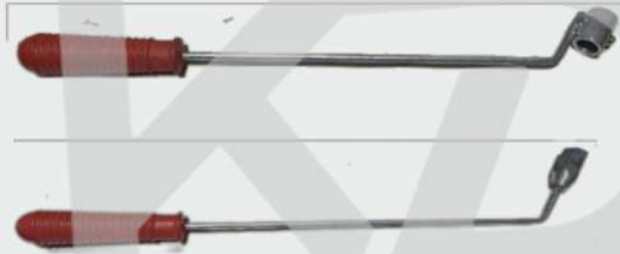

Graphite Stick Handle

Code	Model type	Price
172	Thread Type	
173	Bust Type	

Graphite Crucible Tong Iron

Code	Model type	Price
174	14"	
175	16"	
176	18"	
177	24"	

Graphite Crucible Tong Steel

Code	Model type	Price
178	14"	
179	16"	
180	18"	
181	24"	

Graphite Crucible (Muchh)

Code	Modal Type	Price
182	80x80	
183	80x90	
184	80x100	
185	90x90	
186	90x100	
187	100x100	
188	100x120	
189	100x130	
190	120x120	
191	120x130	



Code	Modal Type	Price
192	100x180	
193	125x175	
194	130x130	
195	145x190	
196	130x180	
197	100x150	
198	170x170	
199	50x100 collar	
200	58x125 (500g)	
201	65x125(1kg)	
202	75x155(2kg)	

Graphite Crucible (Muchh)

<i>Code</i>	<i>Modal Type</i>	<i>Price</i>
203	25x25	
204	30x30	
205	35x35	
206	40x40	
207	40x45	
208	45x45	
209	50x50	
210	50x55	
211	50x60	
212	50x70	
213	50x75	
214	50x65	
215	55x55	
216	60x60	
217	60x65	



<i>Code</i>	<i>Modal Type</i>	<i>Price</i>
218	60x70	
219	60x90	
220	65x65	
221	65x70	
222	65x75	
223	65x90	
224	65x100	
225	70x70	
226	70x90	
227	70x100	
228	75x75	
229	75x80	
230	75x90	
231	75x100	
232	75x125	

Soldering Tools



Graphite Stick Thread Type

Code	Model type	Price
236	6"	



Graphite Carbon Stick

Code	Model type	Price
237	10mm x 12"	
238	12mm x 12"	

Melting Transformer

Code	Model type	Price
233	1 KG	
234	2 KG	
M233	3 KG	
M234	5 KG	

Sensor

Code	Model type	Price
235	Sensor	

Melting tools & Machinery



Melting Furnace

Code	Melting Capacity	Power	Crucible Size	Price
239	250 GM	1000 w	40 X 40 MM	
240	500 GM	1100 w	45 X 45 MM	
241	1 KG	1500 w	65 X 65 MM	
242	2 KG	2000 w	90 X 90 MM	
243	3 KG	2500 w	110 X 110 MM	
244	5 KG	3500 w	125 X 125 MM	



Electric Blower

Code	Modal Type	Price
246	No. 14	
245	No.18	
247	No.25	
248	No.35	
249	No.50	
250	No.60	
251	No.70	

Melting tools & Machinery



Transformer Based Melting Furnace.

<i>Code</i>	<i>Melting Capacity</i>	<i>Power</i>	<i>Crucible Size</i>	<i>Price</i>
<i>252</i>	<i>1 Kg</i>	<i>1500 W</i>	<i>65 x 65 mm</i>	
<i>253</i>	<i>2 Kg</i>	<i>2000 w</i>	<i>90 x 90 mm</i>	

Melting tools & Machinery)



Gold Induction Melting (500gm to 1kg)

Code	Size	Power	Price For 1
254	300 GM	3.5 kv	
255	500 GM	4.5 kv	
256	1 KG	5kv	
257	2 KG	6kv	
258	4 KG	7kv	
259	4.5 KG	4.5kv	
260	5 KG	5kv	
261	8 KG	8kv	
262	10 KG	10kv	

Goldsmith tools & Machinery



Bangle Rod

Code	Model Type	Product Weight	Price
263	2.75"x12"	2.150 kg	
264	3"x15"	2.445 Kg	
265	3.5"x15"	3.100 kg	
266	4" x15"	4.030 kg	
267	5" x15"	5.385 kg	
268	Oval 3" x 15"	2.400 kg	

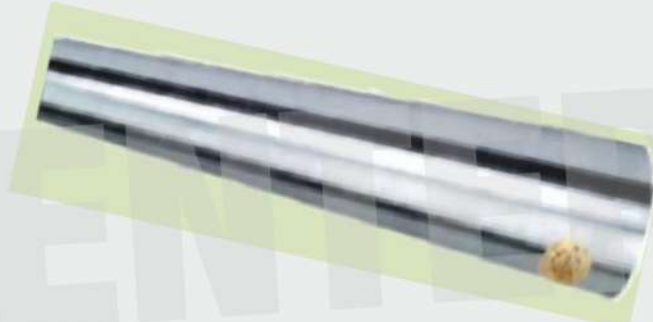

Bangle Rod Steel Plating

Code	Model type	Product Weight	Price
269	2.75"x12"	2.50k g	
270	3" x15"	2.445 kg	
271	3.5" x15"	3.100 kg	
272	4" x15"	4.030 kg	
273	5" x15"	5.385 kg	
274	Oval 3"x15"	2.400 kg	

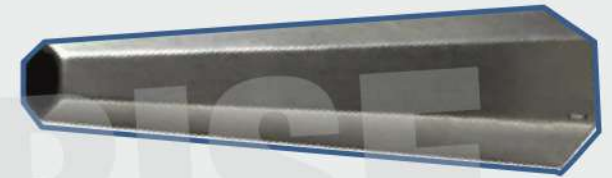

Bangle Rod Octagonal 3"

Code	Model Type	Price
275	Four Part Square 3"x15"	
276	Four Part 3" x15"	
277	Six Part 3" x15"	
278	Eight Part 3" x15"	
279	Ten Part 3" x15"	
280	Twelve Part 3" x15"	
281	Fourteen Part 3" x15"	
282	Sixteen Part 3" x15"	

Goldsmith tools & Machinery



Ring Mandrel Plain

Code	Model Type	Price
288	0.75" x 10"	
289	1" x 10"	
290	1" x 12"	
291	1" x 15"	
292	1.25" x 10"	
293	1.25" x 12"	

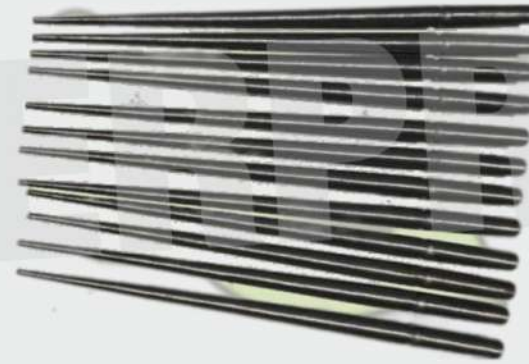

Pointed Ring Mandel

Code	Model type	Price
294	9mm x 6"	
295	12mm x 6"	
296	12mm 8"	
297	12mm x 10"	
298	12mm x 12"	

Goldsmith tools & Machinery



Bangle Divide Line

<i>Code</i>	<i>Model type</i>	<i>Price</i>
<i>283</i>	<i>12 line 3"x15"</i>	
<i>284</i>	<i>24 Line 3"x15"</i>	

Bali Main Drill (Bali Rod)

<i>Code</i>	<i>Model type</i>	<i>Price</i>
<i>285</i>	<i>1 1/2"x12"</i>	
<i>286</i>	<i>2"x12"</i>	

Bangle Rod Stand

<i>Code</i>	<i>Model type</i>	<i>Price</i>
<i>287</i>	<i>Bangle Stand 15"</i>	

Goldsmith tools & Machinery



Alu. Ring Stick 1 to 36

Code	Model type	Price
299	Regular	



Steel Ring Stick 1 to 36

Code	Model type	Price
300	Regular	



Steel Ring Stick 1 to 15

Code	Model type	Price
301	1 TO 15 EXP. QUALITY	



Bangle Seizer 27pcs. Set

Code	Model type	Price
302	Regular	



Bangle Seizer 14pcs. Set

Code	Model type	Price
303	Regular	



Ring Seizer 1 to 36pcs. set

Code	Model type	Price
304	Regular	

Goldsmith tools & Machinery



Wire Set temper

Code	Model type	Price
305	1 to 25	
306	8 to 25	
307	19 to 25	



Gabhali 17pcs. Set

Code	Model type	Price
308	Gabhali Set	

Goldsmith tools & Machinery



Fancy Design Punch 0.5"/0.75"

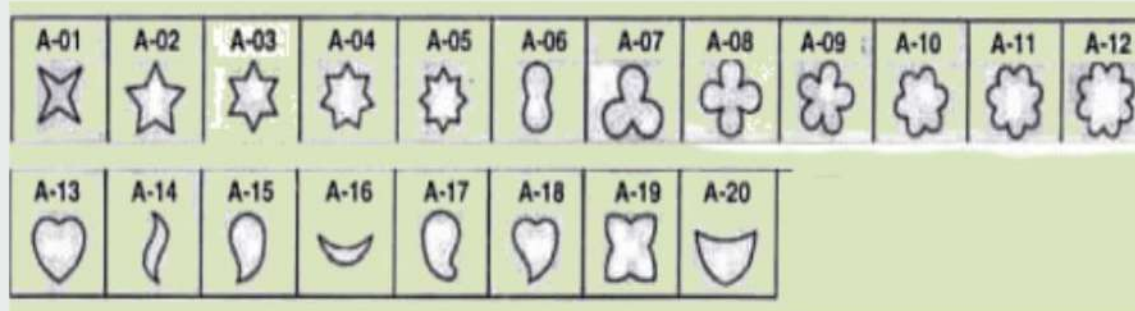

Regular Design Punch 0.5"/0.75"

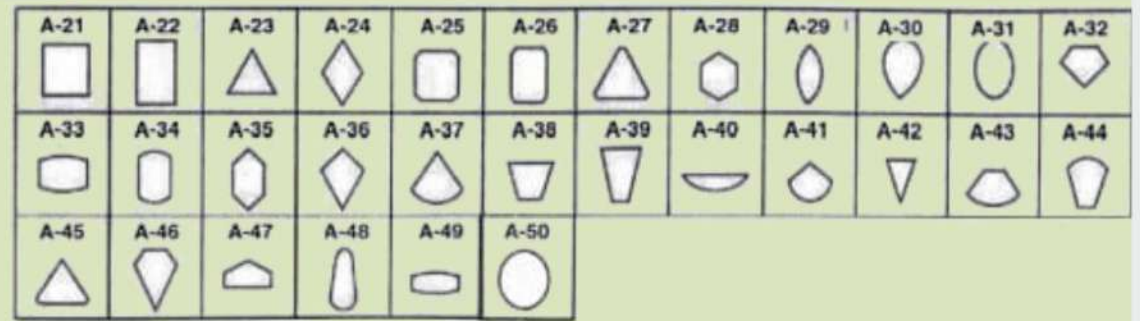

Fancy Design Punch

Code	Model type	Price
309	0.5"	
310	0.75"	

Regular Design Punch

Code	Model type	Price
311	0.5"	
312	0.75"	

Goldsmith tools & Machinery



Ajanta Foot 30Cm

Code	Model Type	Price
313	6" Scale	
314	12" Scale	
A314	18" Scale	



Ring Size

Code	Model Type	Price
A317	Regular	

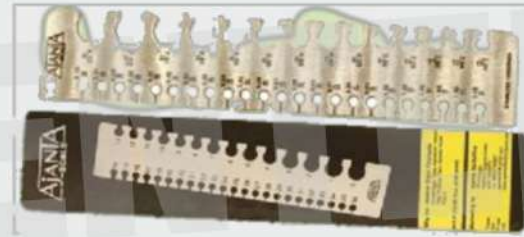

Ajanta Wire Gauge Patti Type

Code	Model Type	Price
315	30 Cm	

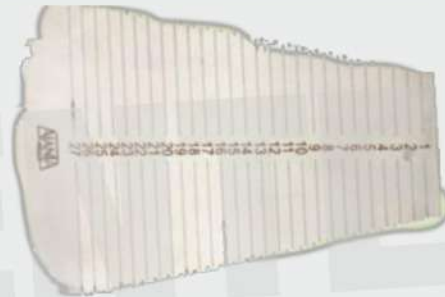

Bangle Size

Code	Model Type	Price
B317	Regular	



Ajanta Bangle Gauge

Code	Model Type	Price
316	Regular	



Ajanta Wire Gauge

Code	Model Type	Price
317	Regular	

Goldsmith tools & Machinery



Big Power

<i>Code</i>	<i>Model type</i>	<i>Price</i>
<i>318</i>	<i>1 to 36</i>	
<i>319</i>	<i>2 to 14</i>	

Hand press Buss

<i>Code</i>	<i>Model type</i>	<i>Price</i>
<i>320</i>	<i>1 number</i>	
<i>321</i>	<i>2 Number</i>	
<i>322</i>	<i>3 Number</i>	

Bender Machine

<i>Code</i>	<i>Model type</i>	<i>Price</i>
<i>323</i>	<i>Bender M/c</i>	

Goldsmith tools & Machinery



Mini Craft Stand

Code	Model type	Price
324	Mini Craft Stand	

Mini Craft Machine Drill

Code	Model type	Price
325	Regular	
326	Heavy	

Eelemeter Power Supply

Code	Model type	Price
327	Regular	

Goldsmith tools & Machinery



LPG. Pipe

Code

Model type

Price

339

¾ 100 miter

Dori Drill

Code

Model type

Price

340

Steel

Pin-Wise Brass 12Pcs.

Code

Model type

Price

341

Regular Yellow

Goldsmith tools & Machinery



Diamond Tools

Code	Model Type	Price
328	0.5mm V/F	
329	1mm V/F	
330	1.5mm V/F	
331	2mm V/F	
332	2.5mm V/F	
333	3mm V/F	
334	4mm V/F	

Air Scriber Diamond Tools

Code	Model Type	Price
335	Diamond	
336	Carbide	

Engraving Tools

Code	Model Type	Price
337	Carbide	



Engraving Machine

Code	Model Type	Price
338	Regular	

Goldsmith tools & Machinery

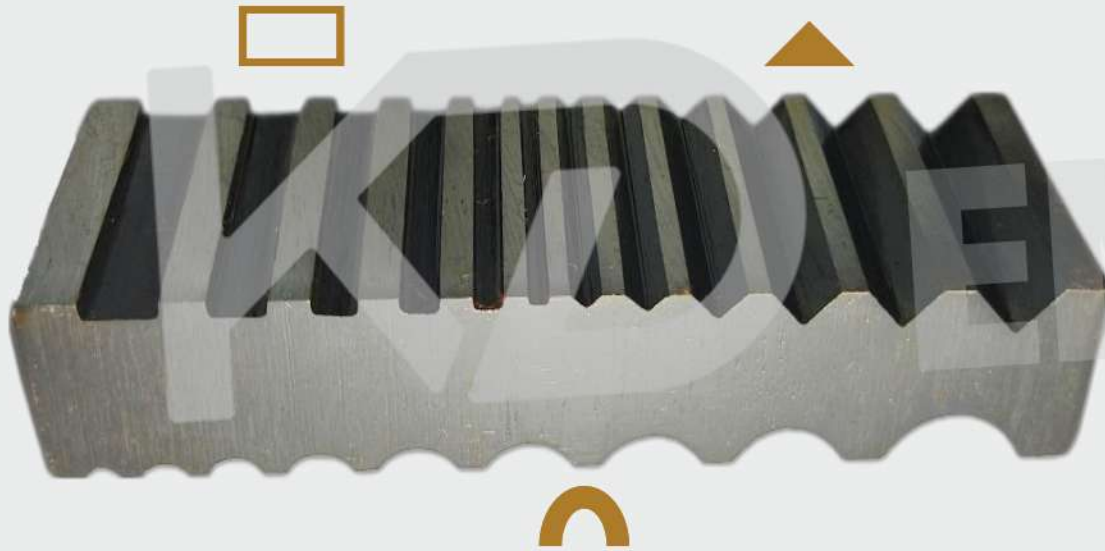

Steel Swag Double Side (V/Half-round/Sure)

Steel Swag Double Side (Half-round)

Code

Model Type

Price

Code

Model Type

Price

348

6"X1.5"

350

6"X1.5"

349

8"X1.5"

A350

6"X2"

351

8" X 1.5"

A351

8" X 2"

Goldsmith tools & Machinery



Steel Swag Single Side Half-Round

<i>Code</i>	<i>Model Type</i>	<i>Price</i>
<i>342</i>	<i>6"X1.5"</i>	
<i>343</i>	<i>6"X2"</i>	
<i>344</i>	<i>8" X 1.5"</i>	
<i>345</i>	<i>8" X 2"</i>	
<i>346</i>	<i>10" X 1.5"</i>	
<i>347</i>	<i>10" X 1.5"</i>	

Goldsmith tools & Machinery

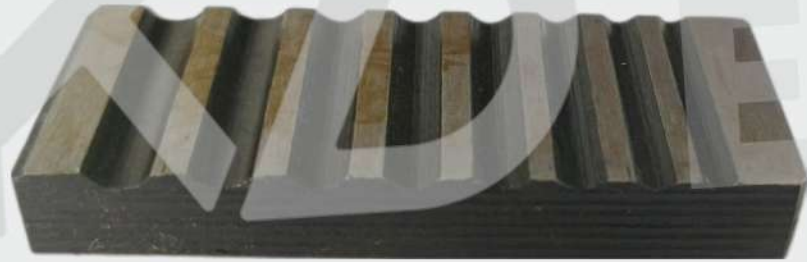

Steel Swag Single Side *Half-Round*

Steel Swag Single Side *Square*

Code

Model Type

Price

Code

Model Type

Price

352

1.5" X 1"

357

2.5" X 1"

353

2.5" X 1"

Goldsmith tools & Machinery



Steel Swag **Single Side**

Steel Swag **Double Side**

Code

Model Type

Price

Code

Model Type

Price

354

2.5"X1.5"X0.75" (HR) SINNGEL

A354

2.5" X 1.5"X1" (HR) DOUBLE

Goldsmith tools & Machinery

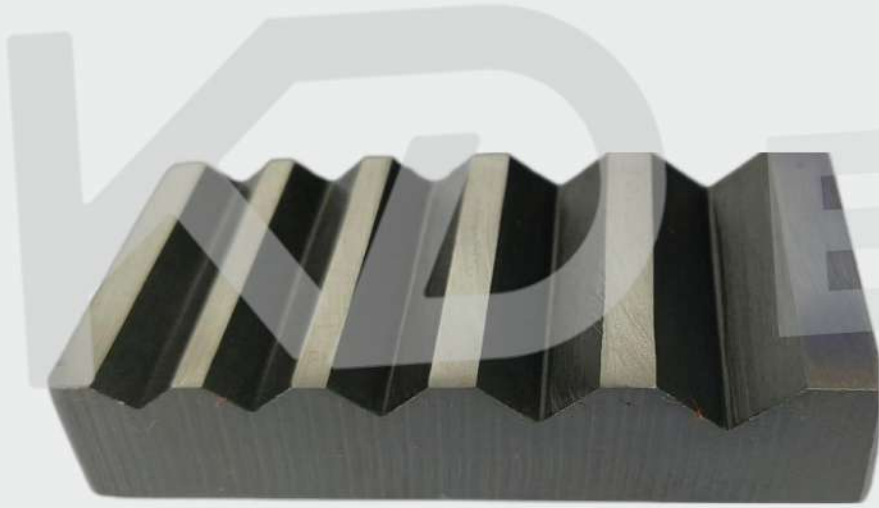

Steel Swag *Single Side*

355	4" X 1.5" (V)	
A355	4" X 1.5" (half-round)	
356	4" X 2" (V)	
A356	4" X 2" (half-round)	



Steel Swag *Double Side*

358	4" X 1.5" (V)	
A358	4" X 1.5" (half-round)	
359	4" X 2." (V)	
A359	4" X 2" (half-round)	

Goldsmith tools & Machinery



Steel Dapping Block

Code	Model Type	Price
360	1" X 1"	
361	1.5" X 1.5"	
362	2" X 2"	
363	2.5" X 2.5"	
364	2.75" X 2.75"	
365	3" X 3"	
366	4" X 4"	

Brass Dapping Block

Code	Model Type	Price	Code	Model Type	Price
367	20"X20" 50gm		374	45"X45" 500gm	
368	25"X25" 120gm		375	48"X48" 650gm	
369	28"X28" 145gm		376	51"X51" 800gm	
370	30"X30" 200gm		377	57"X57" 1.3kg	
371	35"X35" 280gm		378	63"X63" 1.7kg	
372	38"X38" 300gm		379	76"X76" 2.9kg	
373	42"X42" 450gm				

Goldsmith tools & Machinery



Doming Punch Regular

<i>Code</i>	<i>Model Type</i>	<i>Price</i>	<i>Code</i>	<i>Model Type</i>	<i>Price</i>
<i>391</i>	<i>12pcs Set Heavy</i>		<i>396</i>	<i>12pcs Set (Temper)</i>	
<i>392</i>	<i>15pcs Set</i>		<i>397</i>	<i>15pcs Set (Temper)</i>	
<i>393</i>	<i>18pcs Set</i>		<i>398</i>	<i>18pcs Set (Temper)</i>	
<i>394</i>	<i>24pcs Set</i>		<i>399</i>	<i>24pcs Set (Temper)</i>	
<i>395</i>	<i>6pcs Set</i>		<i>400</i>	<i>6Pcs Set (Temper)</i>	

Cutter Punch

<i>Code</i>	<i>Model Type</i>	<i>Price</i>
<i>401</i>	<i>12 Pcs Set</i>	

Goldsmith tools & Machinery



Steel Iron Plate Round

Code	Model Type	Price
380	4"	
381	5"	
382	6"	

Steel Iron Anvil

Code	Model	Weight	Price
383	1.5"x 3"	0.500gm	
384	2"x3"	1kg	
385	2.5"x 3"	2kg	
386	3"x3"	3.742kg	
387	3.5"x 3.5"	5.514kg	
388	4"x4"	8.231kg	
389	5"x5"	16kg	

Steel Dapping Plate

Code	Model Type	Price
390	27 Hole	

Goldsmith tools & Machinery



Ari Frame Fix

<i>Code</i>	<i>Model Type</i>	<i>Price</i>
<i>402</i>	<i>Regular</i>	

Ari Frame Adjustable

<i>Code</i>	<i>Model Type</i>	<i>Price</i>
<i>403</i>	<i>Regular</i>	

Brass Wire Brush

<i>Code</i>	<i>Model Type</i>	<i>Price</i>
<i>404</i>	<i>3 Line</i>	
<i>405</i>	<i>4 Line</i>	
<i>406</i>	<i>5 Line</i>	
<i>407</i>	<i>6 Line</i>	
<i>408</i>	<i>8 Line</i>	

Goldsmith tools & Machinery



Frosting Box

<i>Code</i>	<i>Model Type</i>	<i>Price</i>
<i>409</i>	<i>Frosting Box</i>	

Foot Pedal For Frosting Box

<i>Code</i>	<i>Model Type</i>	<i>Price</i>
<i>410</i>	<i>Regular</i>	

White Sand per kg.

<i>Code</i>	<i>Model Type</i>	<i>Price</i>
<i>411</i>	<i>00 Number Sand</i>	
<i>412</i>	<i>0 Number Sand</i>	
<i>413</i>	<i>1 Number Sand</i>	
<i>414</i>	<i>2 Number Sand</i>	

Goldsmith tools & Machinery

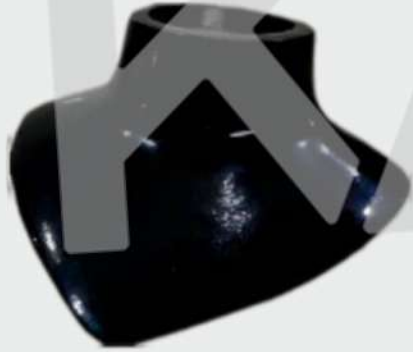

Necklace Stand ALU.

<i>Code</i>	<i>Model Type</i>	<i>Price</i>
434	7.5''X7''X5'' 750gm	

Necklace Stand Alu.

<i>Code</i>	<i>Model Type</i>	<i>Price</i>
435	9.5''X8''X5.5''1.4kg	

Air Scriber Pen

<i>Code</i>	<i>Model Type</i>	<i>Price</i>
436	Regular	

Goldsmith tools & Machinery

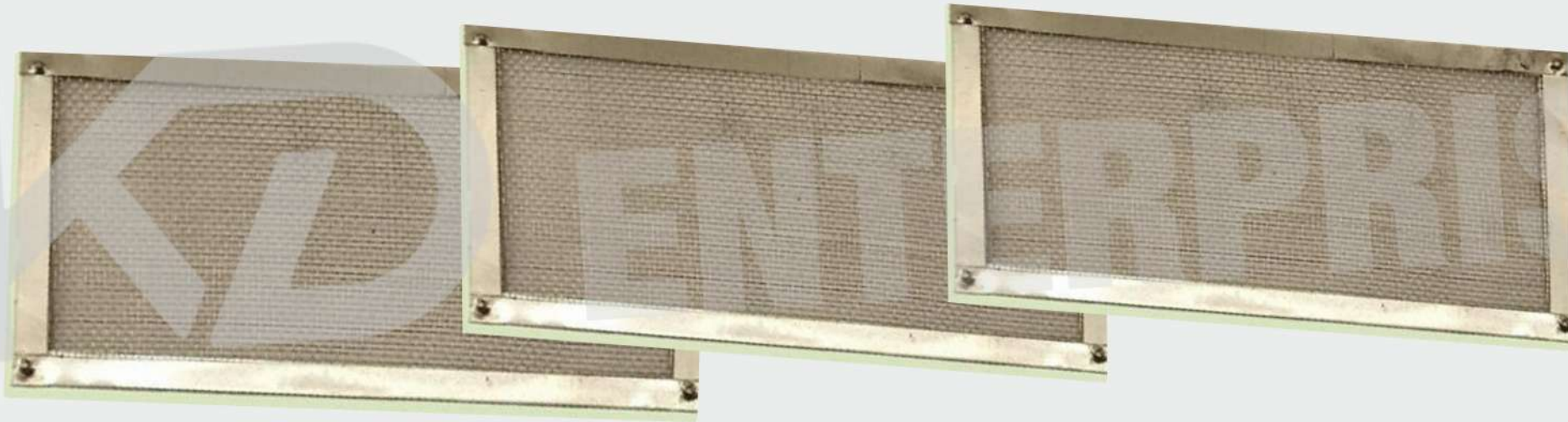

Steel Jari

						<i>Code</i>	<i>Model Type</i>	<i>Price</i>
<i>Code</i>	<i>Model Type</i>	<i>Price</i>	<i>Code</i>	<i>Model Type</i>	<i>Price</i>	<i>Code</i>	<i>Model Type</i>	<i>Price</i>
415	3X10		421	4X4		427	4X12	
416	4X10		422	5X5		428	5X12	
417	5X10		423	4X8		429	6X12	
418	6X10		424	5X8		430	8X8	
419	6X6		425	6X8		431	8X10	
420	6X6 (Putha Jali)		426	3X12		432	10X10	
						433	12X12	

Goldsmith tools & Machinery



2" Design Roll press M/c With 4 Roller Set

2" Design Roller

Code

Model type

Price

448

Regular

Code

Model type

Price

449

Chex. Lining

450

Kittita Design

451

Half Round & V

452

Kittita Lashiya

Goldsmith tools & Machinery



Chakupara M/c. Extra Roller Set

Chakupara Machine

Code	Model Type	Price
437	Regular	

Code	Model Type	Price	Code	Model Type	Price
438	40 No. Design		443	90 No. Design	
439	50 No. Design		444	40 no. Cross Design	
440	60 No. Design		445	50 no. Cross Design	
441	70 No. Design		446	60 no. Cross Design	
442	80 No. Design		447	Fancy Square Design	

Goldsmith tools & Machinery



Wire With Ring Stretcher

Code	Model Type	Price
453	****	

Ring Stretcher M/c Vertical

Code	Model Type	Price
454	****	

Ring Stretcher M/c Heavy

Code	Model Type	Price
455	****	

Goldsmith tools & Machinery



Zigzag M/c With 5 Roller Set

Code	Model Type	Price
456	Regular	
457	Extra 10 Roller Set	

Zigzag M/c. Mini

Code	Model Type	Price
458	Regular	

Zigzag M/c. Italian Type

Code	Model Type	Price
459	Small Steel Finish	
460	Big Steel Finish	

Goldsmith tools & Machinery

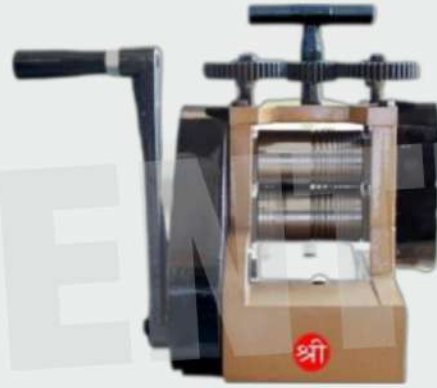

Roll Press M/c Mini

Code	Model Type	Price
461	3"X1.5 D.	
462	3"X1.5 P.	
463	3"X1.5 T.P.	
464	3.5"X2" T.P.	
465	3.5"X2" P.	
466	4"X2" .T.P.	
467	4"X2" P.	

Roll Press M/c. Mini With Cover

Code	Model Type	Price
468	3"X1.5 D.	
469	3"X1.5 P.	
470	3"X1.5 T.P	
471	3.5"X2" T.P.	
472	3.5"X2" P.	
473	4"X2" T.P.	
474	4"X2" P.	

Roll Press M/c.

Code	Model Type	Price
475	4"X2.25" T.P. 60Kg	
476	4"X2.5" P. 60Kg	
477	5"X2.5 T.P. 75Kg	
478	5"X2.5 P. 75Kg	
479	6"X3" T.P. 95Kg	
480	6"X3" P. 95Kg	

Goldsmith tools & Machinery



Roll press M/C. Stand And Motor

Code	Model Type	Price
481	4"X2.25" T.P. 1HP	
482	4"X2.25" P. 1HP.	
483	5"X2.5" T.P. 1.5HP.	
484	5"X2.5" P. 1.5HP.	
485	6"X3" P. 2HP.	
486	6"X3" T.P. 2HP.	



Roll Press M/c. Ele.

Code	Model Type with wt	Price
487	4"X2.25" TP. 110Kg	
488	4"X2.25" P. 110Kg	
489	5"X2.5" TP 130Kg	
490	5"X2.5" P. 130Kg	
491	6"X3" TP. 145Kg	
492	6"X3" P. 145Kg	



Roll Press M/c. Ele. Double Head

Code	Model Type with Wt	Price
493	4"X2.25" TP. 210Kg	
495	5"X2.5" TP. 265Kg	
497	6"X3" TP. 345kg	

Goldsmith tools & Machinery



Roll Press M/c. Eel. Double

Code	Model Type	Price
499	3.5"X2" P. & TP	



Roll Press M/c. Ele.

Code	Model Type	Price
500	5"X2.5" TP/P.	



Roll Press M/c. Stand

Code	Model Type	Price
501	4"/5" M/c. Stand	
502	6" M/c. Stand	

Goldsmith tools & Machinery



3" M/C. Wire Design Roll

Code	Model type	Price
506	Wire	

Wire Design Roller set.

Code	Model type	Price
507	3" M/C. Roller Set	
508	3.5" M/C. Roller Set	
509	4" M/C. Roller Set	

3" M/C. Kitkita Design Roll

Code	Model type	Price
510	Kitkita	

Goldsmith tools & Machinery



3" M/C. Design Roll

<i>Code</i>	<i>Model type</i>	<i>Price</i>
503	Checks, Line & Dull	



3" M/C. Bengal Design Roll

<i>Code</i>	<i>Model type</i>	<i>Price</i>
504	Bangle Design	



3" M/C. Com. Design Roll

<i>Code</i>	<i>Model type</i>	<i>Price</i>
505	Com. Design	

Roll Press M/C. Side Roller



4"x2.25" M/C. Side Roller

Code	Model type	Price
511	Plain	
512	Lashiya V	
513	Checks, Lining, Doule	
514	Kitkita Lasiya	
A514	Kitkita Design	
515	Juddva Design	
516	Chip Bangle Design	
517	Round Tar 2Roller Set	

5"x2.5" M/C. Side Roller

Code	Model type	Price
518	Plain	
519	Lashiya V	
520	Checks, Lining, Doule	
521	Kitkita Lasiya	
A521	Kitkita Design	
522	Juddva Design	
523	Chip Bangle Design	
524	Round Tar 2Roller Set	

Roll Press M/C. Gear



Roll Press Gear

<i>Code</i>	<i>Model type</i>	<i>Price</i>
<i>525</i>	<i>13 Dati Belan Gear Set.</i>	
<i>526</i>	<i>16 Dati Belan Gear Set.</i>	
<i>527</i>	<i>16 Dati Counte Gear Set.</i>	
<i>528</i>	<i>55 Dati Counter Gear</i>	
<i>529</i>	<i>93 Dati Counter Gear</i>	

Jewelry Cleaner M/C.

Vibrator Polisher Machine

Code	Model Type	Media Cap	Tub Size	HP	Price
530	Vibrator M/C. 500gm	5kg	9X4X4	0.12 HP	
531	Vibrator M/C. 1Kg.	10kg	10X6X6	0.25 HP	
532	Vibrator M/C. 2Kg.	15kg	14X6X6	0.5 HP	
533	Vibrator M/C. 3Kg.	20kg	15X7X7	0.5HP	
534	Vibrator M/C. 5Kg.	25kg	18X7X7	0.75 HP	
535	Vibrator M/C. 7Kg.	40kg	20X8X8	1 HP	
536	Vibrator M/C. 8Kg.	50kg	20X9X9	1 HP	
537	Vibrator M/C. 10Kg.	60kg	22X10X10	1 HP	
538	Vibrator M/C. 12Kg.	100kg	24X12X12	1.5 HP	



Jewelry Cleaner M/C. Media & Shampoo



Vibrator M/c. Media

Code	Model Type	Price	Code	Model Type	Price
539	Round Ball 1 mm		548	Cross Pin 1.5X4 mm	
540	Round Ball 1.5 mm		549	Cross Pin 1.5X6 mm	
541	Round Ball 2 mm		550	Cross Pin 1.5X8 mm	
542	Round Ball 2.5 mm		551	Cross Pin 2X4 mm	
543	Round Ball 3 mm		552	Cross Pin 2X6 mm	
544	Round Ball 4 mm		553	Cross Pin 2X8 mm	
545	Cross Pin 1X4 mm		554	B-CON	
546	Cross Pin 1X6 mm		555	D-CON	
547	Cross Pin 1X8 mm		556	All Mix Media	



Shampoo For Gold Cleaner

Code	Model Type	Price
557	1 Liter	



Media Cleaner Powder

Code	Model Type	Price
558	100gm.	

Jewelry Cleaner M/C.



Magnet M/c. Pin

Code	Model Type	Price
563	0.5X5 MM	
564	0.5X4 MM	
565	0.5X3 MM	
566	0.4X5 MM	
567	0.4X4 MM	
568	0.3X5 MM	
569	0.3X4 MM	

Magnetic Polishing M/c.

Code	Model Type	Price
559	0.250 gm	
560	0.500 gm	
561	1Kg	
562	2 Kg	

Wooden Scrape

Code	Model Type	Price
570	200gm.	

Goldsmith tools & Machinery



Polisher Motors

<i>Code</i>	<i>Model Type</i>	<i>Price</i>
<i>571</i>	<i>0.12 HP Polisher</i>	
<i>572</i>	<i>0.25 HP Polisher</i>	
<i>573</i>	<i>0.5 HP Polisher</i>	
<i>574</i>	<i>0.75 HP Polisher</i>	
<i>575</i>	<i>1 HP Polisher</i>	
<i>576</i>	<i>2 HP Polisher</i>	

Polisher Motors 3in1

<i>Code</i>	<i>Model Type</i>	<i>Price</i>
<i>577</i>	<i>0.12 HP Polisher</i>	
<i>578</i>	<i>0.25 HP Polisher</i>	
<i>579</i>	<i>0.5 HP Polisher</i>	
<i>580</i>	<i>0.75 HP Polisher</i>	
<i>581</i>	<i>1 HP Polisher</i>	
<i>582</i>	<i>2 HP Polisher</i>	

Table Drill

<i>Code</i>	<i>Model Type</i>	<i>Price</i>
<i>583</i>	<i>Regular</i>	
<i>584</i>	<i>Universal</i>	

Goldsmith tools & Machinery



Rawa Cutter

Code

Model Type

Price

585

5"

Rawa Cutter Steel Body

Code

Model Type

Price

586

4"

Chira cutter

Code

Model Type

Price

587

5"

Goldsmith tools & Machinery



Tube Forming Hand M/C.

<i>Code</i>	<i>Model Type</i>	<i>Price</i>
<i>588</i>	<i>Manual</i>	
<i>589</i>	<i>Auto 1hp DC Motor</i>	

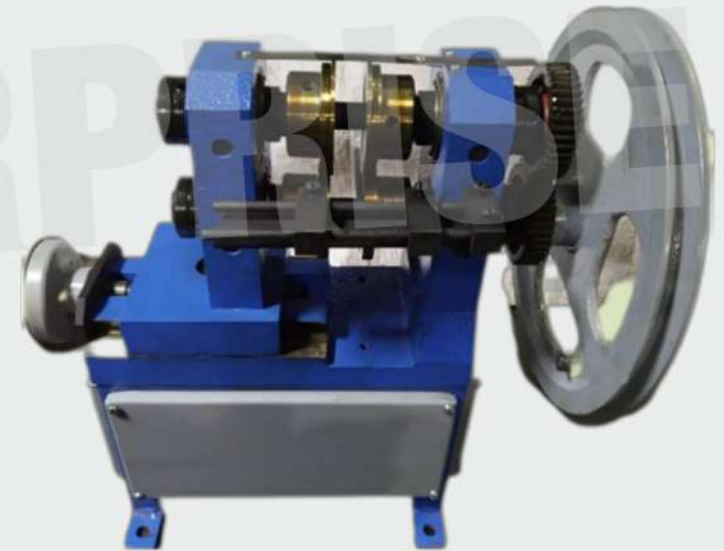

Strep Cutting M/C.

<i>Code</i>	<i>Model Type</i>	<i>Price</i>
<i>590</i>	<i>Strep Cutting M/c.</i>	

Goldsmith tools & Machinery

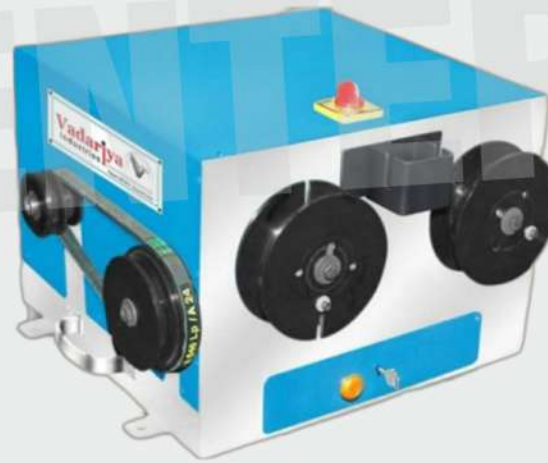
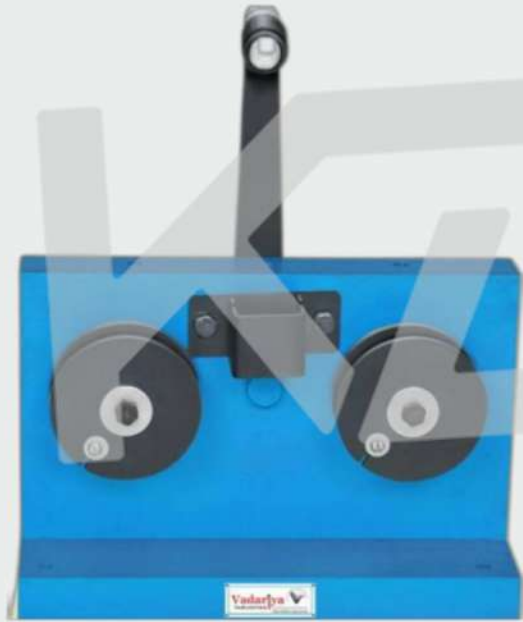

Wire Drawing Manu.

Code	Model Type	Price
591	Manual R/F.	

Wire Drawing Auto

Code	Model Type	Price
592	Auto R/F.	

Wire Drawing Die

Code	Model Type	Price
593	20 To 36 Gage	

Goldsmith tools & Machinery



Ring Flattering M/C.

<i>Code</i>	<i>Model Type</i>	<i>Price</i>
<i>594</i>	<i>Ring Flattering M/c</i>	

Stamping M/c

<i>Code</i>	<i>Model Type</i>	<i>Price</i>
<i>595</i>	<i>Stamping M/c.</i>	

Bangle Sizing M/C.

<i>Code</i>	<i>Model Type</i>	<i>Price</i>
<i>596</i>	<i>Bangle Sizing M/c.</i>	

Goldsmith tools & Machinery



Bangle Expanding M/C.

<i>Code</i>	<i>Model Type</i>	<i>Price</i>
597	***	



Bangle Banding M/C.

<i>Code</i>	<i>Model Type</i>	<i>Price</i>
598	***	

Jewelry Casting M/c. Flash

<i>Code</i>	<i>Modal Type</i>	<i>Price</i>
599	2"X2"	
600	2"X3"	
601	2"X4"	
602	2"X5"	
603	2"X6"	
604	2"X7"	
605	2"X8"	
606	2"X9"	
607	2"X10"	
608	2"X11"	
608	2"X12"	
610	2.5"X2"	
611	2.5"X3"	
612	2.5"X4"	
613	2.5"X5"	



<i>Code</i>	<i>Modal Type</i>	<i>Price</i>
614	2.5"x6"	
615	2.5"X7"	
616	2.5"X8"	
617	2.5"X9"	
618	2.5"X10"	
619	2.5"X11"	
620	2.5"X12"	
621	3"X2"	
622	3"X2"	
623	3"X3"	
624	3"X4"	
625	3"X5"	
626	3"X6"	
627	3"X7"	
628	3"X8"	

Jewelry Casting M/c. Flash

<i>Code</i>	<i>Modal Type</i>	<i>Price</i>
629	3"x9"	
630	3"x10"	
631	3"x11"	
632	3"x12"	
633	3.5"x2"	
634	3.5"x3"	
635	3.5"x4"	
636	3.5"x4"	
637	3.5"x6"	
638	3.5"x7"	
639	3.5"x8"	
640	3.5"x9"	
641	3.5"x10"	
642	3.5"x11"	
643	3.5"x12"	



<i>Code</i>	<i>Modal Type</i>	<i>Price</i>
644	4"x2"	
645	4"x3"	
646	4"x4"	
647	4"x4"	
648	4"x6"	
649	4"x7"	
650	4"x8"	
651	4"x9"	
652	4"x10"	
653	4"x11"	
654	4"x12"	
655	4.5"x2"	
656	4.5"x3"	
657	4.5"x4"	
658	4.5"x5"	

Jewelry Casting M/c. Flash

<i>Code</i>	<i>Modal Type</i>	<i>Price</i>
659	4.5"X5"	
660	4.5"X6"	
661	4.5"X7"	
662	4.5"X8"	
663	4.5"X9"	
664	4.5"X10"	
665	4.5"X11"	
666	4.5"X12"	
667	5"X2"	
668	5"X3"	
669	5"X4"	
670	5"X5"	
671	5"X6"	
672	5"X7"	
673	5"X8"	



<i>Code</i>	<i>Modal Type</i>	<i>Price</i>
674	5"X9"	
675	5"X10"	
676	5"X11"	
677	5"X12"	
678	5.5X2"	
679	5.5"X3"	
680	5.5"X4"	
681	5.5"X5"	
682	5.5"X6"	
683	5.5"X7"	
684	5.5"X8"	
685	5.5"X9"	
686	5.5"X10"	
687	5.5"X11"	
688	5.5"X12"	

Goldsmith tools & Machinery

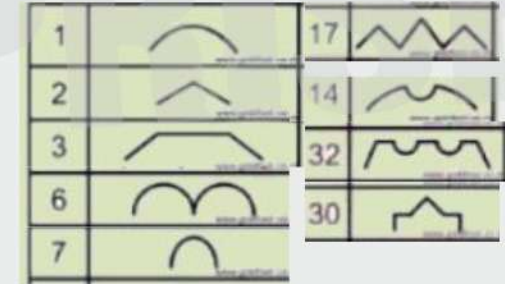

Bangle Grooving M/C.

Code	Model Type	Price
689	****	

Bangle Grooving Dies

Code	Model Type	Price
690	Bangle Grooving Running	
691	Bangle Grooving Fancy	
692	Ring Grooving Running	
693	Ring Grooving Fancy	



Goldsmith tools & Machinery



Vacuum Polisher M/C.

<i>Code</i>	<i>Model Type</i>	<i>Price</i>
<i>694</i>	<i>Single</i>	



Vacuum Polisher M/C.

<i>Code</i>	<i>Model Type</i>	<i>Price</i>
<i>695</i>	<i>Double</i>	

Goldsmith tools & Machinery



Vacuum Polisher M/C.

<i>Code</i>	<i>Model Type</i>	<i>Price</i>
<i>696</i>	<i>Single</i>	



Spring Cutting M/C.

<i>Code</i>	<i>Model Type</i>	<i>Price</i>
<i>697</i>	<i>5mm.</i>	

Goldsmith tools & Machinery



Ball Rolling Dies KANSI



Ball Rolling Drill

Code	Model	Price
698	Regular	
699	Heavy	

Code	4" Size	Price	Code	5" Size	Price	Code	6" Size	Price
700	23 TO 13		709	23 TO 10		717	23 TO 7	
701	20 TO 11		710	20 TO 8		718	20 TO 6	
702	18 TO 10		711	16 TO 7		719	16 TO 5	
703	16 TO 9		712	13 TO 5		720	8 TO 1	
704	13 TO 8		713	9 TO 3		721	7 TO 0	
705	9 TO 5		714	6 TO 1				
706	8 TO 4		715	5 TO 0				
707	4 TO 1		716	1 TO 00				
708	3 TO 0							

Goldsmith tools & Machinery



LPG Melting Floor Model

Code	Modal Type	Price
722	1kg.	
723	3kg.	
724	5kg.	
725	10kg.	



LPG Stand Model

Code	Modal Type	Price
726	1kg.	
727	3kg.	
728	5kg.	
729	10kg.	

Gold Testing Stone



Kasoti (Gold Testing Stone)

Burnished Stick With Handel

<i>Code</i>	<i>Model Type</i>	<i>Price</i>
<i>730</i>	<i>Talwar Shep</i>	
<i>731</i>	<i>Straight</i>	
<i>732</i>	<i>Bend Hockey</i>	

<i>Code</i>	<i>Model Type</i>	<i>Price</i>	<i>Code</i>	<i>Model Type</i>	<i>Price</i>
<i>733</i>	<i>1llx2x6mm</i>		<i>740</i>	<i>6x2x12mm</i>	
<i>734</i>	<i>1llx2x12mm</i>		<i>741</i>	<i>6x3x12mm</i>	
<i>735</i>	<i>2x2x12mm</i>		<i>742</i>	<i>8x3x10mm</i>	
<i>736</i>	<i>2x2llx12mm</i>		<i>743</i>	<i>1llx2llx6mm</i>	
<i>737</i>	<i>3x2x12mm</i>		<i>744</i>	<i>100x80x10mm</i>	
<i>738</i>	<i>4x2x6mm</i>				
<i>739</i>	<i>4x2x12mm</i>				

Soldering Tools



LPG Bologun with Stand

Code

Modal Type

Price

745

Regulars

Soldering Hand Lighter

Code

Modal Type

Price

749

Regulars

3 way PU nipple

Code

Modal Type

Price

750

Regulars

Rhodium Plant



Rhodium Plant

Code

Modal Type

Price

751

18litor.

Jewelry Cleaner M/C.



Ultrasonic Cleaner

Code	Modal Type	Price
752	2litor.	

Ultrasonic Cleaner

Code	Modal Type	Price	Code	Modal Type	Price
753	3litor.		756	9litor.	
754	4.5litor.		757	12litor.	
755	6litor.		758	15litor.	

Goldsmith tools & Machinery



Disc cutter 3"

<i>Code</i>	<i>Model type</i>	<i>Price</i>
<i>759</i>	<i>Square</i>	
<i>760</i>	<i>Oval / Hart / Star</i>	

Goldsmith tools & Machinery



Bezel Block 3"

<i>Code</i>	<i>Model type</i>	<i>Price</i>
<i>761</i>	<i>Round</i>	
<i>762</i>	<i>Oval / Hart / Star / Square / Triangle</i>	